

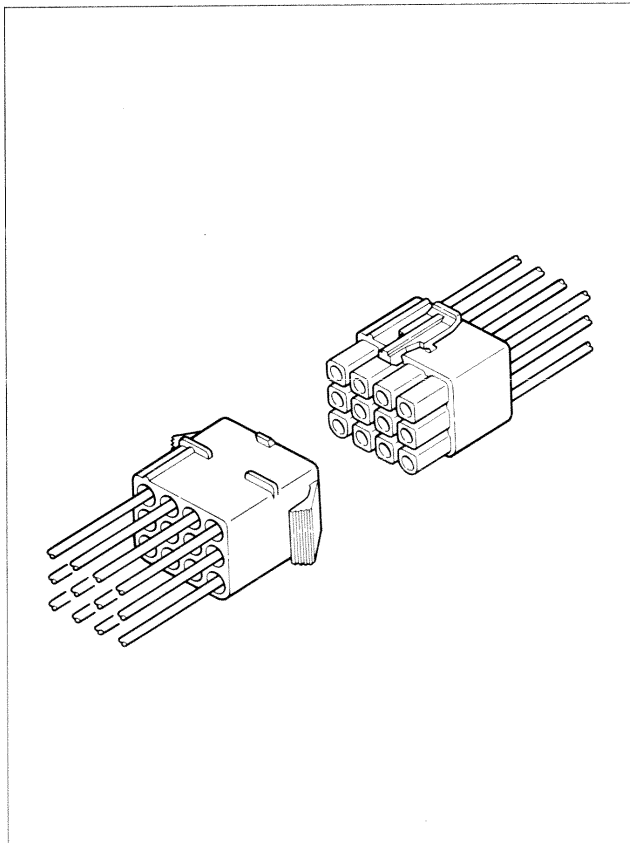

L CONNECTOR

.244" (6.2mm) pitch disconnectable crimp style wire-to-wire connectors

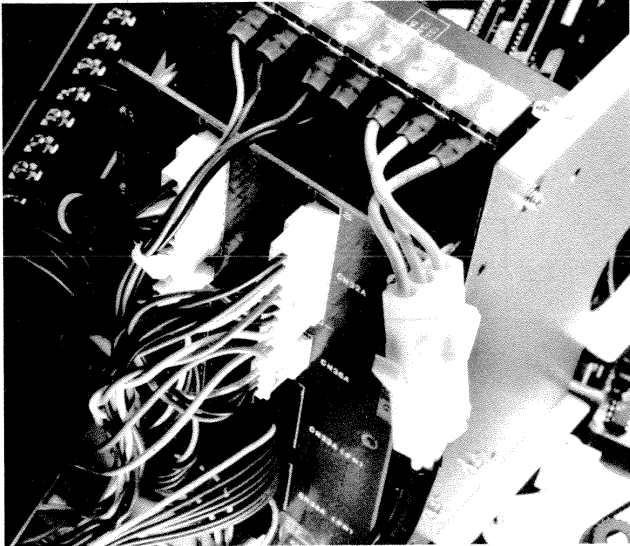

This, the standard connector of the L series, can be used in almost all electric products, including circuits having a current rating of up to 15A.

Features

• Egg-crate housing construction

All contacts are individually and totally surrounded by housing walls (egg-crate style) to protect the contacts against deformation while being mated. This same construction ensures a large electrical creep distance, while a contact pitch of .244" (6.2mm) guarantees safe dielectric spacing. Furthermore, the polarized housing prevents mismatching the connector.

• Easy and secure installation of contacts

The area surrounding the lance of the contact is cleared so that the contact can be easily inserted into the housing. A lance retraction prevention mechanism is also provided.

• Locking mechanism on the panel

Due to our unique panel lock design, the housing can be easily installed on panels of various thicknesses without using tools.

• Arm lock mechanism

An arm lock mechanism securely locks the plug and the receptacle together when they are mated. The lock can be easily released.

The current rating differs depending on the number of circuits and the wire size used in each connector. The table below lists the current rating as a function of the number of circuits and the wire size.

Current unit: A

Circuits	Wire size (AWG)					
	# 14	# 16	# 18	# 20	# 22	# 24
1	15	10	8	6	4	3
2	15	10	8	6	4	3
3	14	9	8	6	4	3
4	13	9	7	6	4	3
6	12	8	7	5	3	2
9	10	7	6	5	3	2
12	9	7	5	4	3	2
15	9	7	5	4	3	2

Specifications

- Current rating: 15A AC, DC max.
- Voltage rating: 300V AC, DC (Single circuit: 600V)
- Temperature range: -25°C to +90°C (including temperature rise)
- Contact resistance: Initial value/10mΩ max. After environmental testing/15mΩ max.
- Insulation resistance: 1,000MΩ min.
- Withstanding voltage: 1,500V AC/minute
- Applicable wire: AWG # 24 to # 14, 0.2 to 2.0mm²
- Applicable panel thickness: .031" to .079" (0.8 to 2.0mm)

* Contact JST for details.

Standards

 Recognized file No. E60389

 Certified file No. LR20812

 File No. R75049 (conforms to DIN/VDE 0627)

Contact

Pin contact

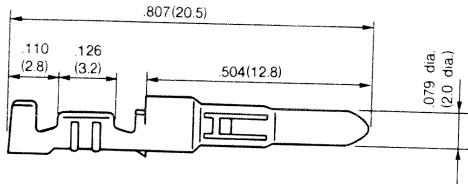

SLM-01T-2.0 · SLM-61T-2.0

Socket contact

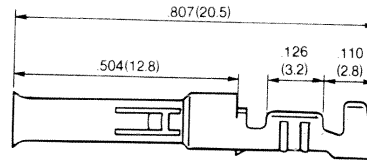

SLF-01T-2.0 · SLM-61T-2.0

Model No.		Applicable wire			Material	Finish	Q'ty/reel
Pin contact	Socket contact	mm ²	AWG #	Insulation O.D. in. (mm)			
SLM-01T-2.0	SLF-01T-2.0	0.2 to 0.5	24 to 20	.059 to .106 (1.5 to 2.7)	Brass	Tin-plated	5,000
SLM-61T-2.0	SLF-61T-2.0	0.5 to 2.0	20 to 14	.075 to .134 (1.9 to 3.4)			3,000

Note
1: Contact JST for special products.

Housing

Material: Nylon 6, UL94V-2 or UL94V-0

Circuits	Voltage rating	Current rating	Receptacle housing (for pin contact)		Plug housing (for socket contact)	
			Model No.	Q'ty/bag	Model No.	Q'ty/bag
1	600V	15A	LR-01F, Nylon 6, UL94V-2 LR-01FV, Nylon 6, UL94V-0	500	LP-01V, Nylon 6, UL94V-2 LP-01V, Nylon 6, UL94V-0	500
2	300V	15A	LR-02F-1, Nylon 6, UL94V-2 LR-02F-1V, Nylon 6, UL94V-0	500	LP-02-1, Nylon 6, UL94V-2 LP-02-1V, Nylon 6, UL94V-2	500
2	300V	15A	LR-02-2, Nylon 6, UL94V-2 LR-02-2V, Nylon 6, UL94V-0	500	LP-02-1, Nylon 6, UL94V-2 LP-02-1V, Nylon 6, UL94V-2	500

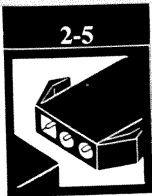

L CONNECTOR

.244" (6.2mm) pitch disconnectable crimp style wire-to-wire connectors

Housing

Material: Nylon 6, UL94V-2 or UL94V-0

Cir- cuits	Voltage rating	Current rating	Receptacle housing (for pin contact)		Plug housing (for socket contact)	
			Part Number	Q'ty/ bag	Part Number	Q'ty/ bag
3	300V	14A	LR-03-1, Nylon 6, UL94V-2	500	LP-03-1, Nylon 6, UL94V-2	500
			LR-03-1V Nylon 6, UL94V-0		LP-03-1V, Nylon 6, UL94V-0	
4	300V	13A	LR-04-2, Nylon 6, UL94V-2	500	LP-04-2, Nylon 6, UL94V-2	500
			LR-04-2V, Nylon 6, UL94V-0		LP-04-2V Nylon 6, UL94V-0	
4	300V	13A	LR-04-1, Nylon 6, UL94V-2	500	LP-04-1, Nylon 6, UL94V-2	500
			LR-04-1V, Nylon 6, UL94V-0		LP-04-1V, Nylon 6, UL94V-0	
6	300V	12A	LR-06-1, Nylon 6, UL94V-2	500	LP-06-1, Nylon 6, UL94V-2	500
			LR-06-1V, Nylon 6, UL94V-0		LP-06-1V, Nylon 6, UL94V-0	

Housing

Material: Nylon 6, UL94V-2 or UL94V-0

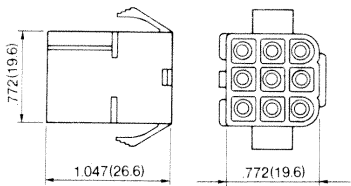
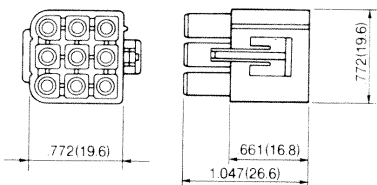
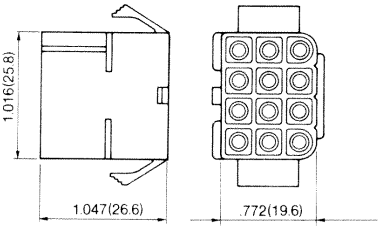
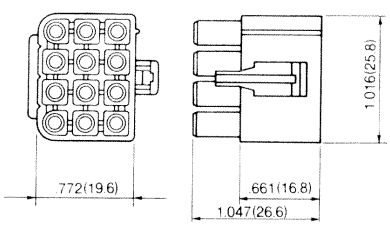
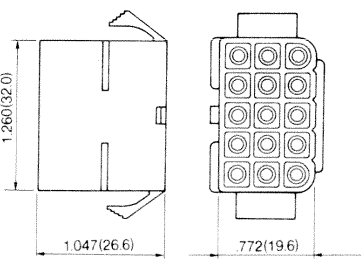
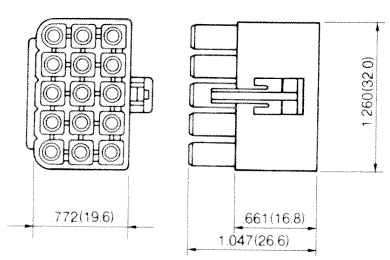
Circuits	Voltage rating	Current rating	Receptacle housing (for pin contact)	Q'ty/ bag	Plug housing (for socket contact)	Q'ty/ bag
9	300V	10A	LR-09-1, Nylon 6, UL94V-2 LR-09-1V, Nylon 6, UL94V-0 	200	LP-09-1, Nylon 6, UL94V-2 LP-09-1V, Nylon 6, UL94V-0 	200
12	300V	9A	LR-12-1, Nylon 6, UL94V-2 LR-12-1V, Nylon 6, UL94V-0 	100	LP-12-1, Nylon 6, UL94V-2 LP-12-1V, Nylon 6, UL94V-0 	100
15	300V	9A	LR-15-1, Nylon 6, UL94V-2 LR-15-1V, Nylon 6, UL94V-0 	100	LP-15-1, Nylon 6, UL94V-2 LP-15-1V, Nylon 6, UL94V-0 	100

Note:
 1. L connectors with any number of circuits can be used either panel mounted or free hanging. The panel hole dimensions are given on the next page.

2. Contact JST for special products.

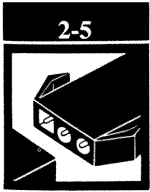

L CONNECTOR

.244" (6.2mm) pitch disconnectable crimp style wire-to-wire connectors

Contact position location numbers

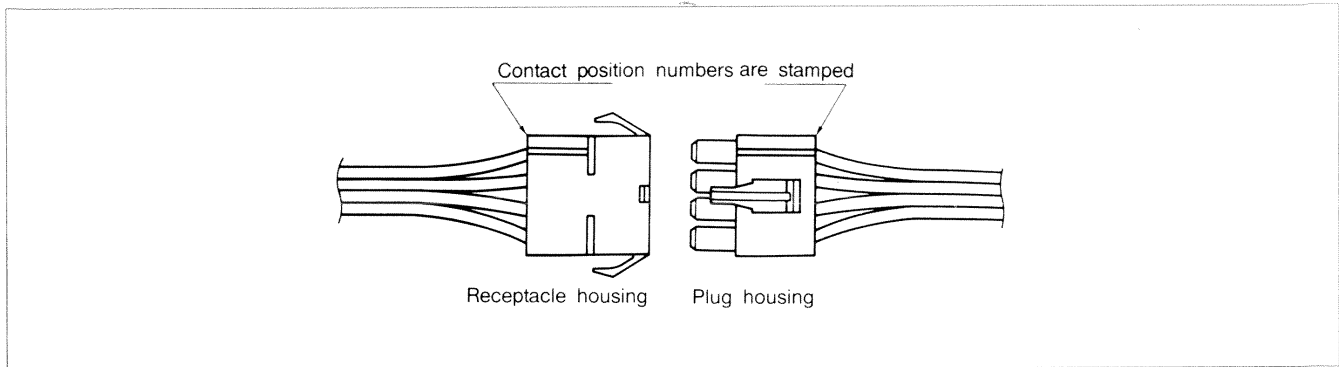

Receptacle housing

4	1	7	4	1	9	5	1	11	6	1
5	2	8	5	2	10	6	2	12	7	2
6	3	9	6	3	11	7	3	13	8	3
		12	8	4	14	9	4			

Plug housing

1	4	1	4	7	1	5	9	1	6	11
2	5	2	5	8	2	6	10	2	7	12
3	6	3	6	9	3	7	11	3	8	13
					4	8	12	4	9	14
								5	10	15

Panel layout

Shape I

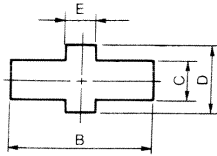

Shape II

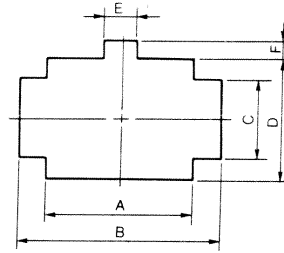

Circuits	Receptacle housing	Applicable hole form	Panel hole dimensions in. (mm) General tolerance $\pm .005(\pm 0.13)$						Applicable panel thickness in. (mm) (0.8 to 2.0)
			A	B	C	D	E	F	
2	LR-02-2 (V)	I	—	.740 (18.8)	.307 (7.8)	.433 (11.0)	.146 (3.7)	—	
3	LR-03-1 (V)	I	—	.984 (25.0)	.307 (7.8)	.433 (11.0)	.146 (3.7)	—	
4	LR-04-2 (V)	I	—	1.228 (31.2)	.307 (7.8)	.433 (11.0)	.146 (3.7)	—	
	LR-04-1 (V)	II	.543 (13.8)	.740 (18.8)	.370 (9.4)	.555 (14.1)	.157 (4.0)	.063 (1.6)	
6	LR-06-1 (V)	II	.787 (20.0)	.984 (25.0)	.370 (9.4)	.555 (14.1)	.157 (4.0)	.063 (1.6)	
9	LR-09-1 (V)	II	.787 (20.0)	.984 (25.0)	.370 (9.4)	.799 (20.3)	.157 (4.0)	.063 (1.6)	
12	LR-12-1 (V)	II	1.031 (26.2)	1.228 (31.2)	.504 (12.8)	.799 (20.3)	.157 (4.0)	.063 (1.6)	
15	LR-15-1 (V)	II	1.276 (32.4)	1.472 (37.4)	.504 (12.8)	.799 (20.3)	.157 (4.0)	.063 (1.6)	

Note:

1. Punch holes in the panel according to the sketch and table shown above. Burrs must be removed.
2. The strength of the panel must be considered when punching two or more holes.
3. The connector must be inserted from the same side as the hole is punched.

Assembly layout

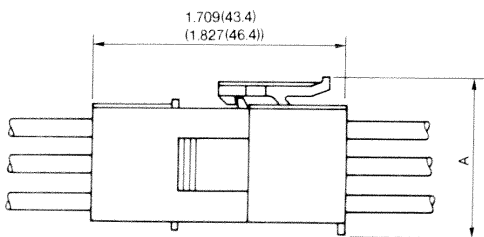

* Dimensions in parentheses apply to the connector with one circuit.

Circuits	Dimension A in. (mm)
1	.435 (11.05)
2 to 4 (Single-line arrangement)	.469 (11.9)
4 (Double-line arrangement) 6	.713 (18.1)
9 to 15	.957 (24.3)